

CDRHxxxR / CDRHxDxx / CDR / CDRH Series

- Ferrite Shielded
- Up to 8 Amps
- Competitive Prices
- Low Profile to 2.0mm
- Typical Reel Size 1000pcs



The **CDR / CDRH** series of ferrite shielded inductors exhibit excellent current handling characteristics.

COMPONENT OUTLINE

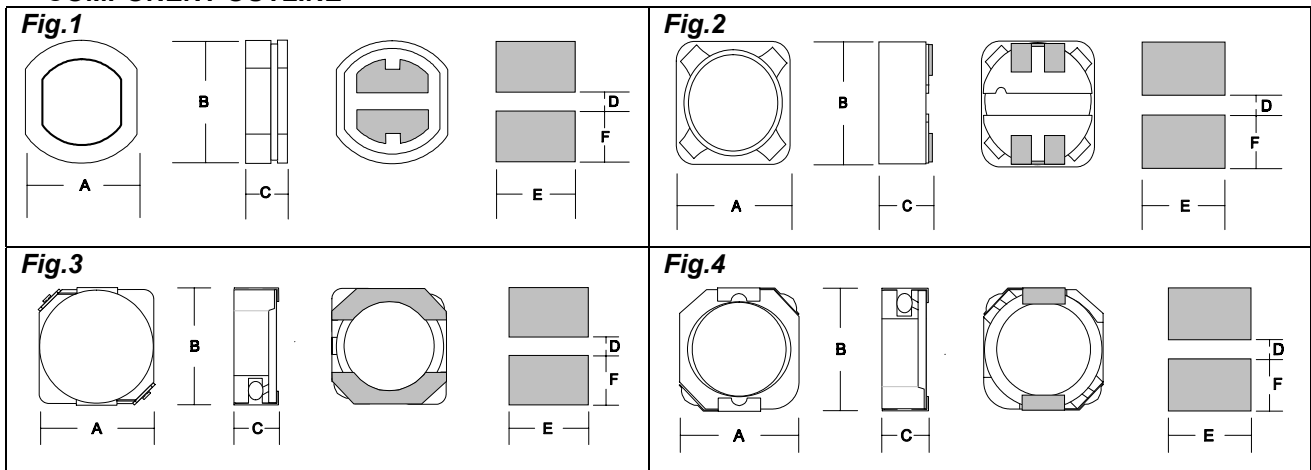

DIMENSIONS

ECM Type	Inductance Range	Fig.	A (mm)	B	C	D	E	F
CDRH103R	10uH ~ 150uH	4	10.30	10.40	3.00	7.30	3.00	1.70
CDRH104R	1.3uH ~ 330uH	4	10.30	10.40	4.00	7.30	3.00	1.70
CDRH105R	10uH ~ 1mH	4	10.30	10.40	5.00	7.30	3.00	1.70
CDRH4D18	1.0uH ~ 39uH	3	4.70	4.70	2.00	1.50	5.30	1.90
CDRH4D28	1.2uH ~ 180uH	3	4.70	4.70	3.00	1.50	5.30	1.90
CDRH5D18	4.1uH ~ 100uH	3	5.70	5.70	2.00	2.00	6.30	2.15
CDRH5D28	2.6uH ~ 100uH	3	5.70	5.70	3.00	2.00	6.30	2.15
CDRH6D28	3.0uH ~ 100uH	3	6.70	6.70	3.00	2.00	7.30	2.65
CDRH6D38	3.3uH ~ 100uH	3	6.70	6.70	4.00	2.00	7.30	2.65
CDRH73	10uH ~ 1.0mH	2	7.30	7.30	3.20	4.80	2.20	1.60
CDRH74	10uH ~ 1.0mH	2	7.30	7.30	4.50	4.80	2.20	1.60
CDRH125	2.1uH ~ 1.0mH	2	12.00	12.00	6.00	7.00	5.40	2.90
CDRH127	2.4uH ~ 1.0mH	2	12.00	12.00	8.00	7.00	5.40	2.90
CDR63B	10uH ~ 68uH	1	5.60	6.20	3.20	1.70	5.50	2.25
CDR74B	10uH ~ 270uH	1	7.00	7.80	4.50	2.00	7.50	4.00
CDR105B	10uH ~ 470uH	1	9.00	10.00	5.00	2.50	9.50	5.00

ECM Surface Mount Power Inductors

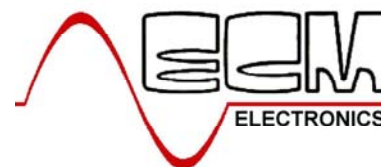

ECM Part	L (μH)	Tol %	R_{DC} MAX (mΩ)	I_{DC} I_N (A)
-----------------	----------------------------------	------------------	--	---

CDRH103R Series

CDRH103R-100	10 @ 100kHz	N	58.1	2.70
CDRH103R-120	12 @ 100kHz	N	72.1	2.25
CDRH103R-150	15 @ 100kHz	N	86.5	2.22
CDRH103R-180	18 @ 100kHz	N	116.1	1.90
CDRH103R-220	22 @ 100kHz	N	145.4	1.78
CDRH103R-270	27 @ 100kHz	N	175.9	1.63
CDRH103R-330	33 @ 100kHz	N	213.4	1.16
CDRH103R-390	39 @ 100kHz	N	268.9	1.32
CDRH103R-470	47 @ 100kHz	N	298.6	1.18
CDRH103R-560	56 @ 100kHz	N	335.8	1.10
CDRH103R-680	68 @ 100kHz	N	451.3	1.04
CDRH103R-820	82 @ 100kHz	N	513.8	0.94
CDRH103R-101	100 @ 100kHz	N	700.0	0.84
CDRH103R-121	120 @ 100kHz	N	765.0	0.76
CDRH103R-151	150 @ 100kHz	N	876.3	0.70

CDRH104R Series

CDRH104R-1R3	1.3 @ 100kHz	N	8.1	10.00
CDRH104R-2R5	2.5 @ 100kHz	N	10	7.50
CDRH104R-3R8	3.8 @ 100kHz	N	13	6.00
CDRH104R-5R2	5.2 @ 100kHz	N	22	5.50
CDRH104R-7R0	7.0 @ 100kHz	N	27	4.80
CDRH104R-100	10 @ 100kHz	N	35	4.40
CDRH104R-150	15 @ 100kHz	N	50	3.60
CDRH104R-220	22 @ 100kHz	N	73	2.90
CDRH104R-330	33 @ 100kHz	N	93	2.30
CDRH104R-470	47 @ 100kHz	N	128	2.10
CDRH104R-680	68 @ 100kHz	N	213	1.50
CDRH104R-101	100 @ 100kHz	N	304	1.35
CDRH104R-151	150 @ 100kHz	N	506	1.15
CDRH104R-221	220 @ 100kHz	N	756	0.92
CDRH104R-331	330 @ 100kHz	N	1090	0.70

CDRH105R Series

CDRH105R-100	10 @ 100kHz	N	25.8	3.45
CDRH105R-120	12 @ 100kHz	N	32.0	3.40
CDRH105R-150	15 @ 100kHz	N	40.0	2.83
CDRH105R-180	18 @ 100kHz	N	46.0	2.62
CDRH105R-220	22 @ 100kHz	N	58.5	2.44
CDRH105R-270	27 @ 100kHz	N	65.4	2.24
CDRH105R-330	33 @ 100kHz	N	81.4	1.88
CDRH105R-390	39 @ 100kHz	N	103.1	1.70
CDRH105R-470	47 @ 100kHz	N	122.1	1.56
CDRH105R-560	56 @ 100kHz	N	144.8	1.39
CDRH105R-680	68 @ 100kHz	N	193.0	1.36
CDRH105R-820	82 @ 100kHz	N	219.4	1.20
CDRH105R-101	100 @ 100kHz	N	247.0	1.09
CDRH105R-121	120 @ 100kHz	N	298.4	1.00
CDRH105R-151	150 @ 100kHz	N	355.1	0.91
CDRH105R-181	180 @ 100kHz	N	393.4	0.84
CDRH105R-221	220 @ 100kHz	N	483.8	0.75
CDRH105R-271	270 @ 100kHz	N	632.5	0.68
CDRH105R-331	330 @ 100kHz	N	780.0	0.60
CDRH105R-391	390 @ 100kHz	N	957.5	0.57
CDRH105R-471	470 @ 100kHz	N	1220.4	0.50
CDRH105R-561	560 @ 100kHz	N	1352.4	0.47
CDRH105R-681	680 @ 100kHz	N	1519.2	0.43
CDRH105R-821	820 @ 100kHz	N	1694.4	0.39
CDRH105R-102	1000 @ 100kHz	N	1946.4	0.35

ECM Electronics Limited, Penmaen House, Ashington, West Sussex, RH20 3JR, UK
 Tel: +44(0)1903 892810; Fax: +44(0)1903 892738. Email: sales@ecmelectronics.co.uk

Although we have attempted to accurately reflect the products we market. ECM reserve the right without prior notice to discontinue any product or make design changes we believe necessary.

ECM Surface Mount Power Inductors

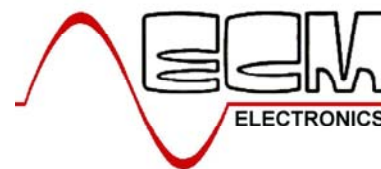

ECM Part	L (μH)	Tol %	R_{DC} MAX (Ω)	I_{DC} I_N (A)
-----------------	----------------------------------	------------------	---	---

CDRH4D18 Series

CDRH4D18-1R0	1.0uH @ 100kHz	N	0.045	1.72
CDRH4D18-2R2	2.2uH @ 100kHz	N	0.075	1.32
CDRH4D18-2R7	2.7uH @ 100kHz	N	0.105	1.28
CDRH4D18-3R3	3.3uH @ 100kHz	N	0.110	1.04
CDRH4D18-3R9	3.9uH @ 100kHz	N	0.155	0.88
CDRH4D18-4R7	4.7uH @ 100kHz	N	0.162	0.84
CDRH4D18-5R6	5.6uH @ 100kHz	N	0.170	0.80
CDRH4D18-6R8	6.8uH @ 100kHz	N	0.200	0.76
CDRH4D18-8R2	8.2uH @ 100kHz	N	0.245	0.68
CDRH4D18-100	10uH @ 100kHz	N	0.200	0.61
CDRH4D18-120	12uH @ 100kHz	N	0.210	0.56
CDRH4D18-150	15uH @ 100kHz	N	0.240	0.50
CDRH4D18-180	18uH @ 100kHz	N	0.338	0.48
CDRH4D18-220	22uH @ 100kHz	N	0.397	0.41
CDRH4D18-270	27uH @ 100kHz	N	0.441	0.35
CDRH4D18-330	33uH @ 100kHz	N	0.694	0.32
CDRH4D18-390	39uH @ 100kHz	N	0.709	0.30

CDRH4D28 Series

CDRH4D28-1R2	1.2uH @ 100kHz	N	0.0236	2.56
CDRH4D28-1R8	1.8uH @ 100kHz	N	0.0275	2.20
CDRH4D28-2R2	2.2uH @ 100kHz	N	0.0313	2.04
CDRH4D28-2R7	2.7uH @ 100kHz	N	0.0433	1.60
CDRH4D28-3R3	3.3uH @ 100kHz	N	0.0492	1.57
CDRH4D28-3R9	3.9uH @ 100kHz	N	0.0648	1.44
CDRH4D28-4R7	4.7uH @ 100kHz	N	0.0720	1.32
CDRH4D28-5R6	5.6uH @ 100kHz	N	0.1009	1.17
CDRH4D28-6R8	6.8uH @ 100kHz	N	0.1089	1.12
CDRH4D28-8R2	8.2uH @ 100kHz	N	0.1175	1.04
CDRH4D28-100	10uH @ 100kHz	N	0.1283	1.00
CDRH4D28-120	12uH @ 100kHz	N	0.1316	0.84
CDRH4D28-150	15uH @ 100kHz	N	0.1490	0.76
CDRH4D28-180	18uH @ 100kHz	N	0.1660	0.72
CDRH4D28-220	22uH @ 100kHz	N	0.2350	0.70
CDRH4D28-270	27uH @ 100kHz	N	0.2610	0.58
CDRH4D28-330	33uH @ 100kHz	N	0.3780	0.56
CDRH4D28-390	39uH @ 100kHz	N	0.3837	0.50
CDRH4D28-470	47uH @ 100kHz	N	0.5870	0.48
CDRH4D28-560	56uH @ 100kHz	N	0.6245	0.41
CDRH4D28-680	68uH @ 100kHz	N	0.6990	0.35
CDRH4D28-820	82uH @ 100kHz	N	0.9148	0.32
CDRH4D28-101	100uH @ 100kHz	N	1.0200	0.29
CDRH4D28-121	120uH @ 100kHz	N	1.2700	0.27
CDRH4D28-151	150uH @ 100kHz	N	1.3500	0.24
CDRH4D28-181	180uH @ 100kHz	N	1.5400	0.22

CDRH5D18 Series

CDRH5D18-4R1	4.1 @ 10kHz	N	0.057	1.95
CDRH5D18-5R4	5.4 @ 10kHz	N	0.076	1.60
CDRH5D18-6R2	6.2 @ 10kHz	N	0.096	1.40
CDRH5D18-8R9	8.9 @ 10kHz	N	0.116	1.25
CDRH5D18-100	10 @ 10kHz	N	0.124	1.20
CDRH5D18-120	12 @ 10kHz	N	0.153	1.10
CDRH5D18-150	15 @ 10kHz	N	0.196	0.97
CDRH5D18-180	18 @ 10kHz	N	0.210	0.85
CDRH5D18-220	22 @ 10kHz	N	0.290	0.80
CDRH5D18-270	27 @ 10kHz	N	0.330	0.75
CDRH5D18-330	33 @ 10kHz	N	0.386	0.65
CDRH5D18-390	39 @ 10kHz	N	0.520	0.57

ECM Electronics Limited, Penmaen House, Ashington, West Sussex, RH20 3JR, UK
 Tel: +44(0)1903 892810; Fax: +44(0)1903 892738. Email: sales@ecmelectronics.co.uk

Although we have attempted to accurately reflect the products we market. ECM reserve the right without prior notice to discontinue any product or make design changes we believe necessary.

ECM Surface Mount Power Inductors

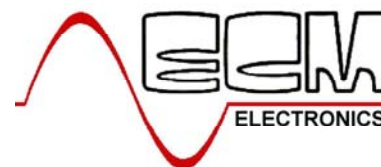

ECM Part	L (μH)	Tol %	R_{DC} MAX (Ω)	I_{DC} I_N (A)
-----------------	----------------------------------	------------------	---	---

CDRH5D18 Series continued...

CDRH5D18-470	47 @ 10kHz	N	0.595	0.54
CDRH5D18-560	56 @ 10kHz	N	0.665	0.50
CDRH5D18-680	68 @ 10kHz	N	0.840	0.43
CDRH5D18-820	82 @ 10kHz	N	0.978	0.41
CDRH5D18-101	100 @ 10kHz	N	1.200	0.36

CDRH5D28 Series

CDRH5D28-2R6	2.6uH @ 10kHz	N	0.018	2.60
CDRH5D28-3R0	3.0uH @ 10kHz	N	0.024	2.40
CDRH5D28-4R2	4.2uH @ 10kHz	N	0.031	2.20
CDRH5D28-5R3	5.3uH @ 10kHz	N	0.038	1.90
CDRH5D28-6R2	6.2uH @ 10kHz	N	0.045	1.80
CDRH5D28-8R2	8.2uH @ 10kHz	N	0.053	1.60
CDRH5D28-100	10uH @ 10kHz	N	0.065	1.30
CDRH5D28-120	12uH @ 10kHz	N	0.076	1.20
CDRH5D28-150	15uH @ 10kHz	N	0.103	1.10
CDRH5D28-180	18uH @ 10kHz	N	0.110	1.00
CDRH5D28-220	22uH @ 10kHz	N	0.122	0.90
CDRH5D28-270	27uH @ 10kHz	N	0.175	0.85
CDRH5D28-330	33uH @ 10kHz	N	0.189	0.75
CDRH5D28-390	39uH @ 10kHz	N	0.212	0.70
CDRH5D28-470	47uH @ 10kHz	N	0.260	0.62
CDRH5D28-560	56uH @ 10kHz	N	0.305	0.58
CDRH5D28-680	68uH @ 10kHz	N	0.355	0.52
CDRH5D28-820	82uH @ 10kHz	N	0.463	0.46
CDRH5D28-101	100uH @ 10kHz	N	0.520	0.42

CDRH6D28 Series

CDRH6D28-3R0	3.0uH @ 10kHz	N	0.024	3.00
CDRH6D28-3R9	3.9uH @ 10kHz	N	0.027	2.60
CDRH6D28-5R0	5.0uH @ 10kHz	N	0.031	2.40
CDRH6D28-6R0	6.0uH @ 10kHz	N	0.035	2.25
CDRH6D28-7R3	7.3uH @ 10kHz	N	0.054	2.10
CDRH6D28-8R6	8.6uH @ 10kHz	N	0.058	1.85
CDRH6D28-100	10uH @ 10kHz	N	0.065	1.70
CDRH6D28-120	12uH @ 10kHz	N	0.070	1.55
CDRH6D28-150	15uH @ 10kHz	N	0.084	1.40
CDRH6D28-180	18uH @ 10kHz	N	0.095	1.32
CDRH6D28-220	22uH @ 10kHz	N	0.128	1.20
CDRH6D28-270	27uH @ 10kHz	N	0.142	1.05
CDRH6D28-330	33uH @ 10kHz	N	0.165	0.97
CDRH6D28-390	39uH @ 10kHz	N	0.210	0.86
CDRH6D28-470	47uH @ 10kHz	N	0.238	0.80
CDRH6D28-560	56uH @ 10kHz	N	0.277	0.73
CDRH6D28-680	68uH @ 10kHz	N	0.304	0.65
CDRH6D28-820	82uH @ 10kHz	N	0.390	0.60
CDRH6D28-101	100uH @ 10kHz	N	0.535	0.54

CDRH6D38 Series

CDRH6D38-3R3	3.3 @ 10kHz	N	0.020	3.50
CDRH6D38-5R0	5.0 @ 10kHz	N	0.024	2.90
CDRH6D38-6R2	6.2 @ 10kHz	N	0.027	2.50
CDRH6D38-7R4	7.4 @ 10kHz	N	0.031	2.30
CDRH6D38-8R7	8.7 @ 10kHz	N	0.034	2.20
CDRH6D38-100	10 @ 10kHz	N	0.038	2.00
CDRH6D38-120	12 @ 10kHz	N	0.053	1.70
CDRH6D38-150	15 @ 10kHz	N	0.057	1.60
CDRH6D38-180	18 @ 10kHz	N	0.092	1.50
CDRH6D38-220	22 @ 10kHz	N	0.096	1.30

ECM Electronics Limited, Penmaen House, Ashington, West Sussex, RH20 3JR, UK
Tel: +44(0)1903 892810; Fax: +44(0)1903 892738. Email: sales@ecmelectronics.co.uk

Although we have attempted to accurately reflect the products we market. ECM reserve the right without prior notice to discontinue any product or make design changes we believe necessary.

ECM Surface Mount Power Inductors

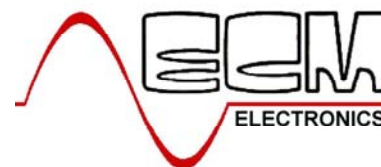

ECM Part	L (μH)	Tol %	R_{DC} MAX (Ω)	I_{DC} I_N (A)
-----------------	----------------------------------	------------------	---	---

CDRH6D38 Series continued...

CDRH6D38-270	27 @ 10kHz	N	0.109	1.20
CDRH6D38-330	33 @ 10kHz	N	0.124	1.10
CDRH6D38-390	39 @ 10kHz	N	0.138	1.00
CDRH6D38-470	47 @ 10kHz	N	0.155	0.95
CDRH6D38-560	56 @ 10kHz	N	0.202	0.85
CDRH6D38-680	68 @ 10kHz	N	0.234	0.75
CDRH6D38-820	82 @ 10kHz	N	0.324	0.70
CDRH6D38-101	100 @ 10kHz	N	0.358	0.65

CDRH73 Series

CDRH73-100	10 @ 2.52 MHz	L,M	0.07	1.68
CDRH73-120	12 @ 2.52 MHz	L,M	0.10	1.52
CDRH73-150	15 @ 2.52 MHz	L,M	0.13	1.33
CDRH73-180	18 @ 2.52 MHz	L,M	0.14	1.20
CDRH73-220	22 @ 2.52 MHz	L,M	0.19	1.07
CDRH73-270	27 @ 2.52 MHz	L,M	0.21	0.96
CDRH73-330	33 @ 2.52 MHz	L,M	0.24	0.91
CDRH73-390	39 @ 2.52 MHz	L,M	0.32	0.77
CDRH73-470	47 @ 2.52 MHz	L,M	0.36	0.76
CDRH73-560	56 @ 2.52 MHz	L,M	0.47	0.68
CDRH73-680	68 @ 2.52 MHz	L,M	0.52	0.61
CDRH73-820	82 @ 2.52 MHz	L,M	0.69	0.57
CDRH73-101	100 @ 1.0 kHz	L,M	0.79	0.50
CDRH73-121	120 @ 1.0 kHz	L,M	0.89	0.49
CDRH73-151	150 @ 1.0 kHz	L,M	1.27	0.43
CDRH73-181	180 @ 1.0 kHz	L,M	1.45	0.39
CDRH73-221	220 @ 1.0 kHz	L,M	1.65	0.35
CDRH73-271	270 @ 1.0 kHz	L,M	2.31	0.32
CDRH73-331	330 @ 1.0 kHz	L,M	2.62	0.28
CDRH73-391	390 @ 1.0 kHz	L,M	2.94	0.26
CDRH73-471	470 @ 1.0 kHz	L,M	4.18	0.24
CDRH73-561	560 @ 1.0 kHz	L,M	4.67	0.22
CDRH73-681	680 @ 1.0 kHz	L,M	5.73	0.19
CDRH73-821	820 @ 1.0 kHz	L,M	6.54	0.18
CDRH73-102	1000 @ 1.0 kHz	L,M	9.44	0.16

CDRH74 Series

CDRH74-100	10 @ 2.52 MHz	L,M	0.05	1.84
CDRH74-120	12 @ 2.52 MHz	L,M	0.06	1.71
CDRH74-150	15 @ 2.52 MHz	L,M	0.08	1.47
CDRH74-180	18 @ 2.52 MHz	L,M	0.09	1.31
CDRH74-220	22 @ 2.52 MHz	L,M	0.11	1.23
CDRH74-270	27 @ 2.52 MHz	L,M	0.15	1.12
CDRH74-330	33 @ 2.52 MHz	L,M	0.17	0.96
CDRH74-390	39 @ 2.52 MHz	L,M	0.23	0.91
CDRH74-470	47 @ 2.52 MHz	L,M	0.26	0.88
CDRH74-560	56 @ 2.52 MHz	L,M	0.35	0.75
CDRH74-680	68 @ 2.52 MHz	L,M	0.38	0.69
CDRH74-820	82 @ 2.52 MHz	L,M	0.43	0.61
CDRH74-101	100 @ 1.0 kHz	L,M	0.61	0.60
CDRH74-121	120 @ 1.0 kHz	L,M	0.66	0.52
CDRH74-151	150 @ 1.0 kHz	L,M	0.88	0.46
CDRH74-181	180 @ 1.0 kHz	L,M	0.98	0.42
CDRH74-221	220 @ 1.0 kHz	L,M	1.17	0.36
CDRH74-271	270 @ 1.0 kHz	L,M	1.64	0.34
CDRH74-331	330 @ 1.0 kHz	L,M	1.86	0.32
CDRH74-391	390 @ 1.0 kHz	L,M	2.85	0.29
CDRH74-471	470 @ 1.0 kHz	L,M	3.01	0.26
CDRH74-561	560 @ 1.0 kHz	L,M	3.62	0.23

ECM Electronics Limited, Penmaen House, Ashington, West Sussex, RH20 3JR, UK
 Tel: +44(0)1903 892810; Fax: +44(0)1903 892738. Email: sales@ecmelectronics.co.uk

Although we have attempted to accurately reflect the products we market. ECM reserve the right without prior notice to discontinue any product or make design changes we believe necessary.

ECM Surface Mount Power Inductors

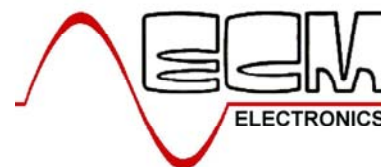

ECM Part	L (μH)	Tol %	R_{DC} MAX (Ω)	I_{DC} I_N (A)
-----------------	----------------------------------	------------------	---	---

CDRH74 Series continued...

CDRH74-681	680 @ 1.0 kHz	L,M	4.63	0.22
CDRH74-821	820 @ 1.0 kHz	L,M	5.20	0.20
CDRH74-102	1000 @ 1.0 kHz	L,M	6.00	0.18

CDRH125 Series

CDRH125-2R1	2.1 @ 100 kHz	M	0.02	7.00
CDRH125-3R1	3.1 @ 100 kHz	M	0.02	6.00
CDRH125-4R4	4.4 @ 100 kHz	M	0.02	5.00
CDRH125-5R8	5.8 @ 100 kHz	M	0.02	4.40
CDRH125-7R5	7.5 @ 100 kHz	M	0.02	4.20
CDRH125-100	10 @ 1.0 kHz	M	0.03	4.00
CDRH125-150	15 @ 1.0 kHz	M	0.03	3.30
CDRH125-180	18 @ 1.0 kHz	M	0.04	3.00
CDRH125-220	22 @ 1.0 kHz	M	0.04	2.80
CDRH125-330	33 @ 1.0 kHz	L,M	0.06	2.10
CDRH125-390	39 @ 1.0 kHz	L,M	0.07	2.00
CDRH125-470	47 @ 1.0 kHz	L,M	0.08	1.80
CDRH125-560	56 @ 1.0 kHz	L,M	0.11	1.70
CDRH125-680	68 @ 1.0 kHz	L,M	0.12	1.50
CDRH125-820	82 @ 1.0 kHz	L,M	0.14	1.40
CDRH125-101	100 @ 1.0 kHz	L,M	0.16	1.30
CDRH125-121	120 @ 1.0 kHz	L,M	0.17	1.10
CDRH125-151	150 @ 1.0 kHz	L,M	0.23	1.00
CDRH125-181	180 @ 1.0 kHz	L,M	0.29	0.90
CDRH125-221	220 @ 1.0 kHz	L,M	0.40	0.80
CDRH125-271	270 @ 1.0 kHz	L,M	0.46	0.75
CDRH125-331	330 @ 1.0 kHz	L,M	0.51	0.68
CDRH125-471	470 @ 1.0 kHz	L,M	0.77	0.58
CDRH125-561	560 @ 1.0 kHz	L,M	0.86	0.54
CDRH125-681	680 @ 1.0 kHz	L,M	1.20	0.48
CDRH125-821	820 @ 1.0 kHz	L,M	1.34	0.43
CDRH125-102	102 @ 1.0 kHz	L,M	1.53	0.40

CDRH127 Series

CDRH127-2R4	2.4 @ 100 kHz	M	0.01	8.00
CDRH127-3R5	3.5 @ 100 kHz	M	0.01	7.50
CDRH127-4R7	4.7 @ 100 kHz	M	0.02	6.80
CDRH127-6R1	6.1 @ 100 kHz	M	0.02	6.60
CDRH127-7R6	7.6 @ 100 kHz	M	0.02	5.90
CDRH127-100	10 @ 1.0 kHz	M	0.02	5.40
CDRH127-150	15 @ 1.0 kHz	M	0.03	4.50
CDRH127-180	18 @ 1.0 kHz	M	0.04	3.90
CDRH127-220	22 @ 1.0 kHz	M	0.04	3.60
CDRH127-330	33 @ 1.0 kHz	L,M	0.06	3.00
CDRH127-390	39 @ 1.0 kHz	L,M	0.07	2.75
CDRH127-470	47 @ 1.0 kHz	L,M	0.10	2.50
CDRH127-560	56 @ 1.0 kHz	L,M	0.11	2.35
CDRH127-680	68 @ 1.0 kHz	L,M	0.14	2.10
CDRH127-820	82 @ 1.0 kHz	L,M	0.16	1.95
CDRH127-101	100 @ 1.0 kHz	L,M	0.22	1.70
CDRH127-121	120 @ 1.0 kHz	L,M	0.25	1.60
CDRH127-151	150 @ 1.0 kHz	L,M	0.28	1.42
CDRH127-181	180 @ 1.0 kHz	L,M	0.35	1.30
CDRH127-221	220 @ 1.0 kHz	L,M	0.39	1.16
CDRH127-271	270 @ 1.0 kHz	L,M	0.56	1.06
CDRH127-331	330 @ 1.0 kHz	L,M	0.64	0.95
CDRH127-471	470 @ 1.0 kHz	L,M	0.98	0.79
CDRH127-561	560 @ 1.0 kHz	L,M	1.07	0.73
CDRH127-681	680 @ 1.0 kHz	L,M	1.46	0.67

ECM Electronics Limited, Penmaen House, Ashington, West Sussex, RH20 3JR, UK
 Tel: +44(0)1903 892810; Fax: +44(0)1903 892738. Email: sales@ecmelectronics.co.uk

Although we have attempted to accurately reflect the products we market. ECM reserve the right without prior notice to discontinue any product or make design changes we believe necessary.

ECM Surface Mount Power Inductors

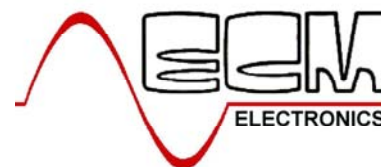

ECM Part	L (μH)	Tol %	R_{DC} MAX (Ω)	I_{DC} I_N (A)
-----------------	----------------------------------	------------------	---	---

CDRH127 Series continued...

CDRH127-821	820 @ 1.0 kHz	L,M	1.64	0.60
CDRH127-102	102 @ 1.0 kHz	L,M	1.82	0.55

CDR63B Series

CDR63B-100	10 @ 2.52 MHz	M	0.14	1.00
CDR63B-120	12 @ 2.52 MHz	M	0.16	0.94
CDR63B-150	15 @ 2.52 MHz	M	0.18	0.86
CDR63B-220	22 @ 2.52 MHz	M	0.25	0.76
CDR63B-270	27 @ 2.52 MHz	M	0.32	0.64
CDR63B-330	33 @ 2.52 MHz	L,M	0.36	0.61
CDR63B-390	39 @ 2.52 MHz	L,M	0.41	0.53
CDR63B-470	47 @ 2.52 MHz	L,M	0.51	0.50
CDR63B-560	56 @ 2.52 MHz	L,M	0.72	0.46
CDR63B-680	68 @ 2.52 MHz	L,M	0.82	0.42

CDR74B Series

CDR74B-100	10 @ 2.52 MHz	M	0.07	1.65
CDR74B-120	12 @ 2.52 MHz	M	0.07	1.57
CDR74B-150	15 @ 2.52 MHz	M	0.08	1.39
CDR74B-180	18 @ 2.52 MHz	M	0.10	1.29
CDR74B-220	22 @ 2.52 MHz	M	0.13	1.12
CDR74B-270	27 @ 2.52 MHz	M	0.16	1.06
CDR74B-330	33 @ 2.52 MHz	M	0.18	0.97
CDR74B-390	39 @ 2.52 MHz	M	0.18	0.91
CDR74B-470	47 @ 2.52 MHz	M	0.27	0.80
CDR74B-560	56 @ 2.52 MHz	L,M	0.29	0.76
CDR74B-680	68 @ 2.52 MHz	L,M	0.33	0.68
CDR74B-820	82 @ 2.52 MHz	L,M	0.43	0.62
CDR74B-101	100 @ 1.0 kHz	L,M	0.49	0.55
CDR74B-121	120 @ 1.0 kHz	L,M	0.68	0.49
CDR74B-151	150 @ 1.0 kHz	L,M	0.94	0.44
CDR74B-181	180 @ 1.0 kHz	L,M	1.00	0.40
CDR74B-221	220 @ 1.0 kHz	L,M	1.18	0.36
CDR74B-271	270 @ 1.0 kHz	L,M	1.30	0.33

CDR105B Series

CDR105B-100	10 @ 2.52 MHz	M	0.06	2.06
CDR105B-120	12 @ 2.52 MHz	M	0.07	1.94
CDR105B-150	15 @ 2.52 MHz	M	0.07	1.72
CDR105B-180	18 @ 2.52 MHz	M	0.08	1.58
CDR105B-220	22 @ 2.52 MHz	M	0.08	1.42
CDR105B-270	27 @ 2.52 MHz	M	0.10	1.32
CDR105B-330	33 @ 2.52 MHz	M	0.11	1.16
CDR105B-390	39 @ 2.52 MHz	M	0.12	1.10
CDR105B-470	47 @ 2.52 MHz	M	0.14	1.00
CDR105B-560	56 @ 2.52 MHz	L,M	0.19	0.93
CDR105B-680	68 @ 2.52 MHz	L,M	0.21	0.85
CDR105B-820	82 @ 2.52 MHz	L,M	0.28	0.79
CDR105B-101	100 @ 1.0 kHz	L,M	0.34	0.72
CDR105B-121	120 @ 1.0 kHz	L,M	0.37	0.63
CDR105B-151	150 @ 1.0 kHz	L,M	0.51	0.55
CDR105B-181	180 @ 1.0 kHz	L,M	0.57	0.50
CDR105B-221	220 @ 1.0 kHz	L,M	0.78	0.47
CDR105B-271	270 @ 1.0 kHz	L,M	0.87	0.41
CDR105B-331	330 @ 1.0 kHz	L,M	1.20	0.37
CDR105B-391	390 @ 1.0 kHz	L,M	1.34	0.35
CDR105B-471	470 @ 1.0 kHz	L,M	1.50	0.33

Tolerance. L=10% M=20% N=30%.

ECM Electronics Limited, Penmaen House, Ashington, West Sussex, RH20 3JR, UK
Tel: +44(0)1903 892810: Fax: +44(0)1903 892738. Email: sales@ecmelectronics.co.uk

Although we have attempted to accurately reflect the products we market. ECM reserve the right without prior notice to discontinue any product or make design changes we believe necessary.